

SAMSUNG

VRF

Technical

Data Book

Wind-Free 4Way Cassette
for North America

(R410A, HP)



Model : AM***NN4DCH/**

Nomenclature

Indoor Unit

Model Name

AM	015	N	N	N	D	C	H	/	**
(1)	(2)	(3)	(4)	(5)	(6)	(7)	(8)		Buyer

(1) Classification

AM	DVM
----	-----

(5) Product Notation

N	(Wind-Free) 4Way Cassette(600x600)
4	(Wind-Free) 4Way Cassette

(2) Capacity

X kBtu/h (3digits)

(6) Feature

P	Premium
D	Deluxe

(3) Version

K	2016
M	2017
N	2018

(7) Rating Voltage

C	1Φ, 208~230V, 60Hz
---	--------------------

(4) Product Type

N	Indoor Unit
X	Outdoor Unit

(8) Mode

H	Heat Pump (R410A)
---	-------------------

1. Specification

Wind-Free 4Way Cassette (600x600)

Type			4Way CASSETTE (600x600)	4Way CASSETTE (600x600)	4Way CASSETTE (600x600)	
Model Name			AM005NNNDCH/AA	AM007NNNDCH/AA	AM009NNNDCH/AA	
Power Supply		Φ, #, V, Hz	1,2,208-230,60	1,2,208-230,60	1,2,208-230,60	
Mode			-	HP/HR	HP/HR	
Performance	TON	Cooling	Ton	0.42	0.63	0.79
			kW	1.47	2.20	2.78
	Btu/h		5,000	7,500	9,500	
	Capacity	Heating	kW	1.76	2.55	3.08
			Btu/h	6,000	8,700	10,500
			US RT	0.50	0.73	0.88
Power	Power Input	Cooling	W	18.00	18.00	24.00
		Heating		18.00	18.00	24.00
	Current Input	Cooling	A	0.17	0.17	0.17
		Heating		0.17	0.17	0.17
	Current	MCA	A	0.24	0.24	0.24
		MOP		15	15	15
Heat exchanger	Type	-	Fin & tube	Fin & tube	Fin & tube	
	Material	Fin	-	Al	Al	Al
		Tube	-	Cu	Cu	Cu
	Fin Treatment	-	Louver, Hydrophile	Louver, Hydrophile	Louver, Hydrophile	
Fan	Type	-	Turbo Fan	Turbo Fan	Turbo Fan	
	Quantity	EA	1	2	3	
	Air Flow Rate	H/M/L	m ³ /min	8.50/7.20/6.50	9.00/7.70/6.50	10.00/8.50/7.50
			ft ³ /min	300/254/230	318/272/230	353/300/265
			l/s	142/120/108	150/128/108	167/142/125
	External Pressure	Max. (Min/Std/Max)	mmAq	-	-	-
Pa			-	-	-	
In Wg			-	-	-	
Fan Motor	Type	-	BLDC	BLDC	BLDC	
	Output x n	W	65 x 1	65 x 1	65 x 1	
Piping Connections	Liquid Pipe	Type	Flare connection	Flare connection	Flare connection	
		Φ, mm (inch)	6.35 (1/4)	6.35 (1/4)	6.35 (1/4)	
	Gas Pipe	Type	Flare connection	Flare connection	Flare connection	
		Φ, mm (inch)	12.70 (1/2)	12.70 (1/2)	12.70 (1/2)	
Heat insulation	-					
Drain Pipe	Φ,mm	VP25 (OD 32,ID 25)	VP25 (OD 32,ID 25)	VP25 (OD 32,ID 25)		
Wiring connections	Communication	Min.	mm ²	2 X 16 AWG SHIELDED	2 X 16 AWG SHIELDED	2 X 16 AWG SHIELDED
		Remark	-			
Refrigerant	Type	-	R410A	R410A	R410A	
	Electronic Expansion Valve	-	EEV INCLUDED	EEV INCLUDED	EEV INCLUDED	
Sound	Sound Pressure Level	H/M/L	dB(A)	30/28/23	32/29/25	33/30/26
	Sound Power	Cooling		46	47	50
External Dimension	Net Weight		kg (lbs)	11.7 (25.8)	12.0 (26.5)	12.0 (26.5)
	Shipping Weight		kg (lbs)	13.7 (30.2)	14.0 (30.9)	14.0 (30.9)
	Net Dimensions (WxHxD)	mm		575 x 250 x 575	575 x 250 x 575	575 x 250 x 575
		inch		22 5/8 x 9 13/16 x 22 5/8	22 5/8 x 9 13/16 x 22 5/8	22 5/8 x 9 13/16 x 22 5/8
	Shipping Dimensions (WxHxD)	mm		623 x 298 x 653	623 x 298 x 653	623 x 298 x 653
inch		24 5/16 x 11 5/16 x 24 5/16	24 5/16 x 11 5/16 x 24 5/16	24 5/16 x 11 5/16 x 24 5/16		
Casing	Material		-	HIPS	HIPS	HIPS

1. Specification

Wind-Free 4Way Cassette (600x600)

Type			4Way CASSETTE (600x600)	4Way CASSETTE (600x600)	4Way CASSETTE (600x600)	
Model Name			AM005NNNDCH/AA	AM007NNNDCH/AA	AM009NNNDCH/AA	
Panel	Model Name	-	PC4SUFMAN PC4SUFMUN	PC4SUFMAN PC4SUFMUN	PC4SUFMAN PC4SUFMUN	
	Type	-	Wind Free Type	Wind Free Type	Wind Free Type	
	Material		HIPS	HIPS	HIPS	
	Color	-	White	White	White	
	Net Weight	kg (lbs)	2.7 (6.0)	2.7 (6.0)	2.7 (6.0)	
	Shipping Weight	kg (lbs)	3.9 (8.6)	3.9 (8.6)	3.9 (8.6)	
	Net Dimensions (W×H×D)	mm		620 x 57 x 620	620 x 57 x 620	620 x 57 x 620
		inch		24 5/16 x 2 1/4 x 24 5/16	24 5/16 x 2 1/4 x 24 5/16	24 5/16 x 2 1/4 x 24 5/16
Shipping Dimensions (W×H×D)	mm		670 x 120 x 655	670 x 120 x 655	670 x 120 x 655	
	inch		27 5/16 x 4 5/16 x 27 5/16	27 5/16 x 4 5/16 x 27 5/16	27 5/16 x 4 5/16 x 27 5/16	
Drain Pump	Drain Pump	-	included	included	included	
	Max. lifting Height / Displacement	in / gal/h	29-5/16 6.34gal/h	29-5/16 6.34gal/h	29-5/16 6.34gal/h	
Additional Accessories	Drain Pump	External Model	-	-	-	
		Internal Model	-	-	-	
		Max. lifting Height / Displacement	in / gal/h	-	-	-
	Air Filter	-	-	-	-	

NOTE

- Specification may be subject to change without prior notice.
 - 1) Mode : HP(Heat Pump), HR(Heat Recovery)
 - 2) Performances are based on the following test conditions.
 - Cooling : Indoor temperature : 80°F(26.7°C) DB, 67°F(19.4°C) WB, Outdoor temperature : 95°F(35°C) DB, 75°F(23.9°C) WB
 - Heating : Indoor temperature : 70°F(21.1°C) DB, 60°F(15.6°C) WB, Outdoor temperature : 47°F(8.3°C) DB, 43°F(6.1°C) WB
 - Equivalent refrigerant pipe length 25ft(7.5m), Level differences 0ft(0m)
 - 3) Sound pressure level is obtained in an anechoic room.
 - Sound pressure level is a relative value, depending on the distance and acoustic environment.
 - Sound pressure level may differ depending on operation condition.
 - dBA = A-weighted sound pressure level
 - Reference acoustic pressure 0 dB = 20uPa
 - 4) Sound power level is an absolute value that a sound source generates.
 - dBA = A-weighted sound power level
 - Reference power : 1pW
 - Measured according to ISO 3741
 - 5) These products contain R410A which is fluorinated greenhouse gas.
 - 6) Select wire size based on the value of MCA

2. Summary Table

Wind-Free 4Way Cassette (600x600)

Performance Characteristics

Model Code	Net Weight (lbs)	Fan Speed	Nominal Capacity(Btu/h)			Airflow (CFM)	Sound Pressure (dBA)	Sound Power (dBA)
			Cooling	Sensible	Heating			
AM005NNNDCH/AA	25.8	High	5,000	4,500	6,000	300	30	46
		Mid	4,300	3,900	5,500	254	28	-
		Low	3,900	3,500	5,200	230	23	-
AM007NNNDCH/AA	26.5	High	7,500	5,100	8,700	318	32	47
		Mid	6,500	4,400	8,000	272	29	-
		Low	5,600	3,800	7,400	230	25	-
AM009NNNDCH/AA	26.5	High	9,500	6,700	10,500	353	33	50
		Mid	8,200	5,800	9,700	300	30	-
		Low	7,300	5,100	9,100	265	26	-
AM012NNNDCH/AA	26.5	High	12,000	8,300	13,500	371	34	51
		Mid	11,000	7,600	12,800	336	30	-
		Low	9,400	6,500	11,800	283	26	-
AM018NNNDCH/AA	26.5	High	18,000	12,400	20,000	459	39	56
		Mid	15,500	10,700	18,400	389	36	-
		Low	13,600	9,400	17,100	336	33	-
AM020NNNDCH/AA	26.5	High	20,000	15,000	23,000	477	40	57
		Mid	18,100	13,600	21,700	424	38	-
		Low	15,600	11,700	20,000	360	35	-

NOTE

- Sound data is based on cooling operation.

Electric Characteristics

Indoor Unit	Power Supply (Ø, #, V, Hz)	Power Input (W)	Current Input (A)	MCA (A)	MFA (A)	FLA (A)
AM005NNNDCH/AA	1,2,208~230,60	18	0.17	0.41	15	0.33
AM007NNNDCH/AA	1,2,208~230,60	18	0.17	0.41	15	0.33
AM009NNNDCH/AA	1,2,208~230,60	24	0.17	0.41	15	0.33
AM012NNNDCH/AA	1,2,208~230,60	28	0.19	0.41	15	0.33
AM018NNNDCH/AA	1,2,208~230,60	36	0.27	0.41	15	0.33
AM020NNNDCH/AA	1,2,208~230,60	38	0.3	0.41	15	0.33

NOTE

- MCA : Minimum circuit amperes
- MFA : Maximum fuse amperes
- FLA : Full load amperes
- Select wire size based on the value of MCA

4. Dimensional Drawing

Wind-Free 4Way Cassette (600x600)

AM005/007/009/012/018/020NNNDCH/AA

Units : mm [inches]

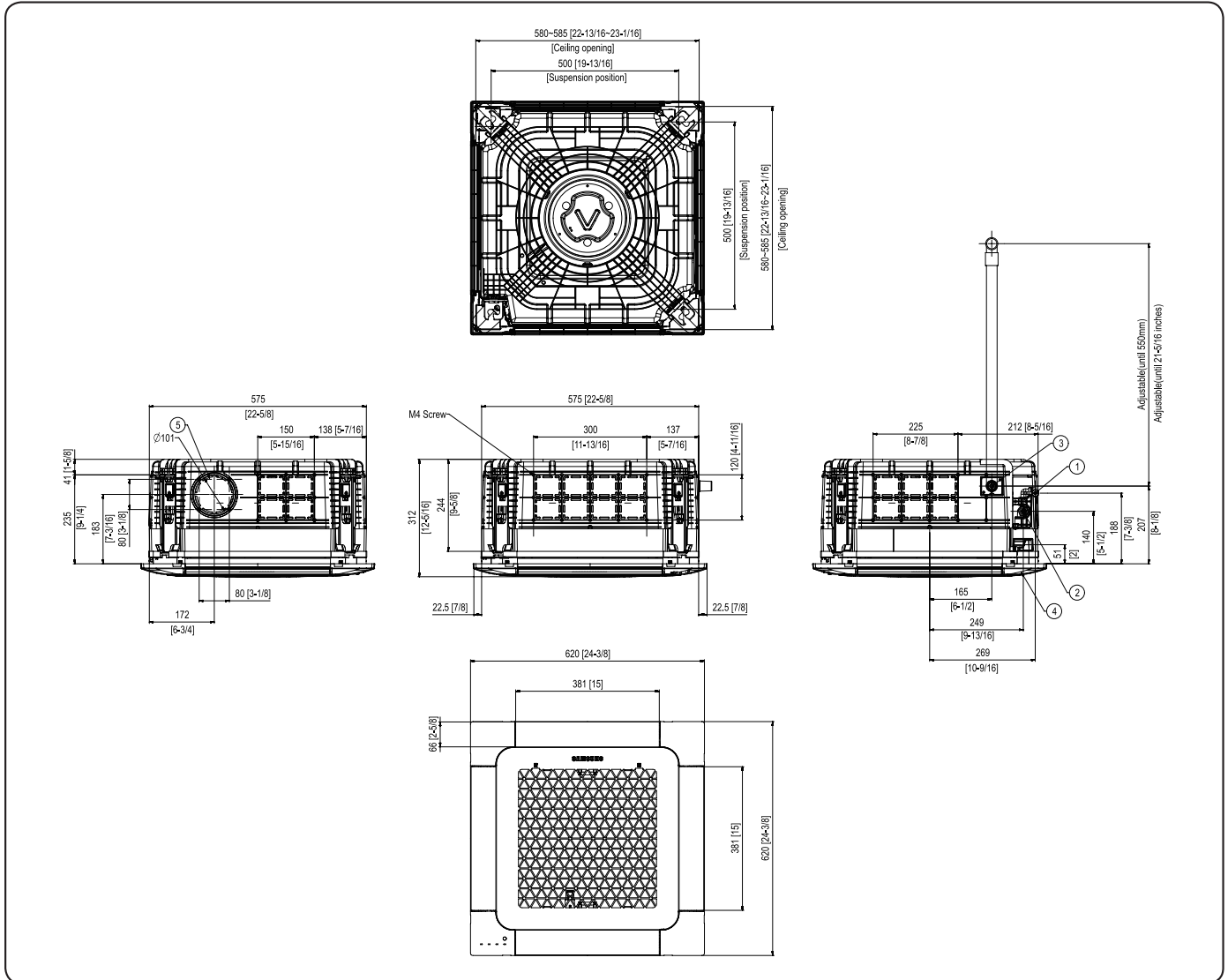

No.	Name	Description
1	Liquid pipe connection	Φ6.35(1/4)
2	Gas pipe connection	Φ12.7(1/2)
3	Drain pipe connection	VP-25(OD32, ID25)
4	Power supply & Communication wiring conduit	Use M4 Screw
5	Fresh air intake knockout hole	Φ10[4] , Use M4 Screw

NOTE

- As for suspension bolt, please use M8 ~ M10. (Procured at local site)

6. Electrical Wiring Diagram

Wind-Free 4Way Cassette (600x600)

AM005/007/009/012/018/020NNNDCH/AA

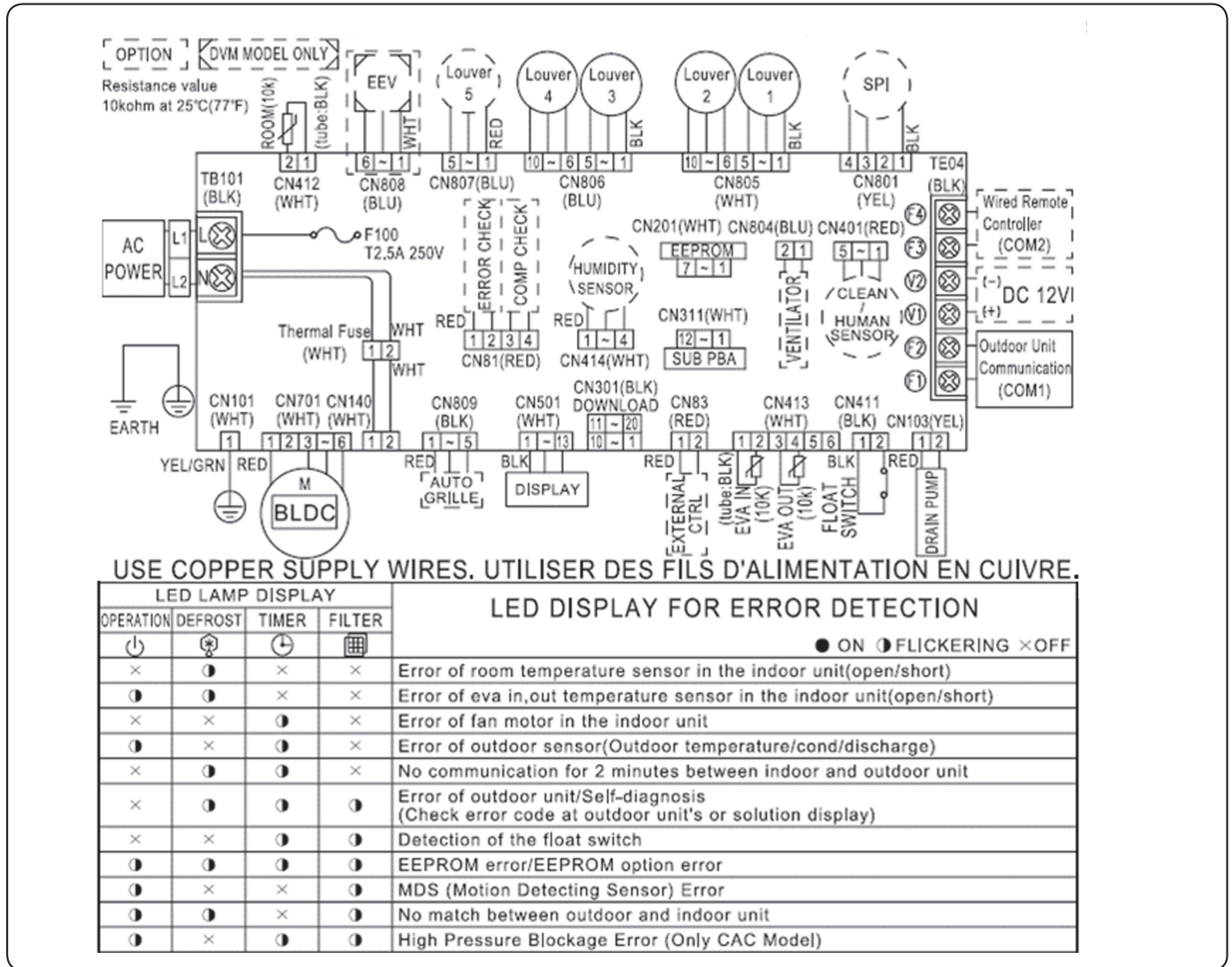

F100	FUSE	SPI	S-Plasma ion	ROOM(10K)	Thermistor ROOM OUT(10K)
M-BLDC	BLDC Motor	EEV	Electronic Expansion Valve	EVA-IN(10K)	Thermistor EVA IN(10K)
		EXT_CONTROL	EXTERNAL_CONTROL	EVA-OUT(10K)	Thermistor EVA OUT(10K)

NOTE

- This wiring diagram applies only to the Indoor unit.
- Symbols show as follow :
blk: black, red: red, blu: blue, wht: white, yel: yellow, brn: brown, sky: skyblue: grn: green
- For connection wiring indoor-outdoor transmission F1-F2, indoor-wired remote controller transmission F3-F4.
- ⚡ Protective earth(screw), □□□□ : connector, $\frac{N}{x}$: The wire quantity

7. Sound Data

Wind-Free 4Way Cassette (600x600)

Sound Pressure level

Unit: dB(A)

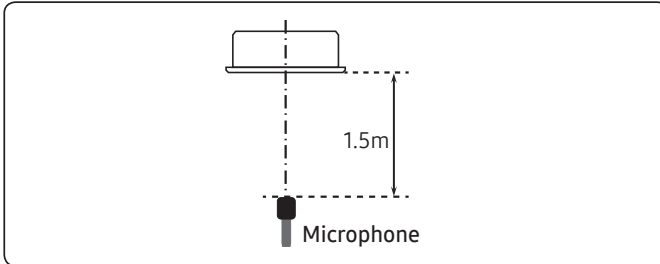

Model	High	MID	LOW
AM005NNNDCH/AA	30	28	23
AM007NNNDCH/AA	32	29	25
AM009NNNDCH/AA	33	30	26
AM012NNNDCH/AA	34	30	26

- NC Curve

1) AM005NNNDCH/AA

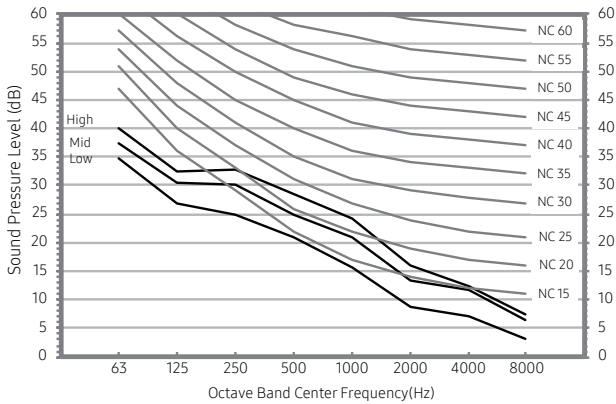

2) AM007NNNDCH/AA

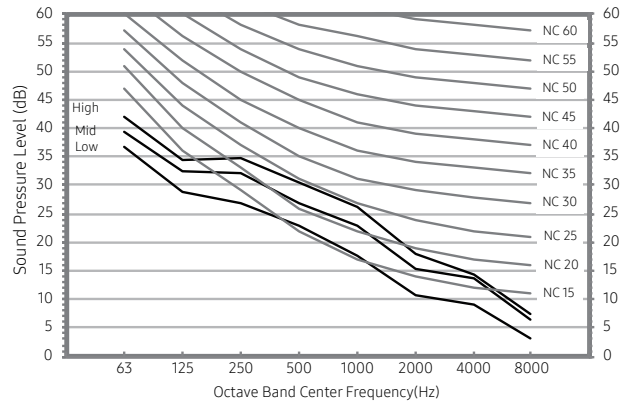

3) AM009NNNDCH/AA

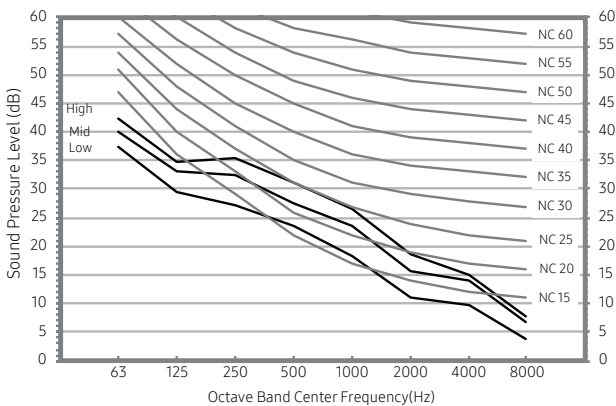

4) AM012NNNDCH/AA

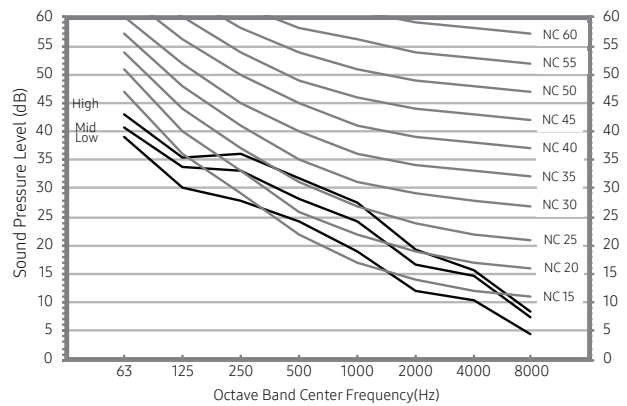

NOTE

- Specifications may be subject to change without prior notice.
 - Sound pressure level is obtained in an anechoic room.
 - Sound pressure level is a relative value, depending on the distance and acoustic environment.
 - Sound pressure level may differ depending on operation condition.
 - dBA = A weighted sound pressure level
 - Reference acoustic pressure 0 dB = 20μPa

9. Piping Diagram

Wind-Free 4Way Cassette (600x600)

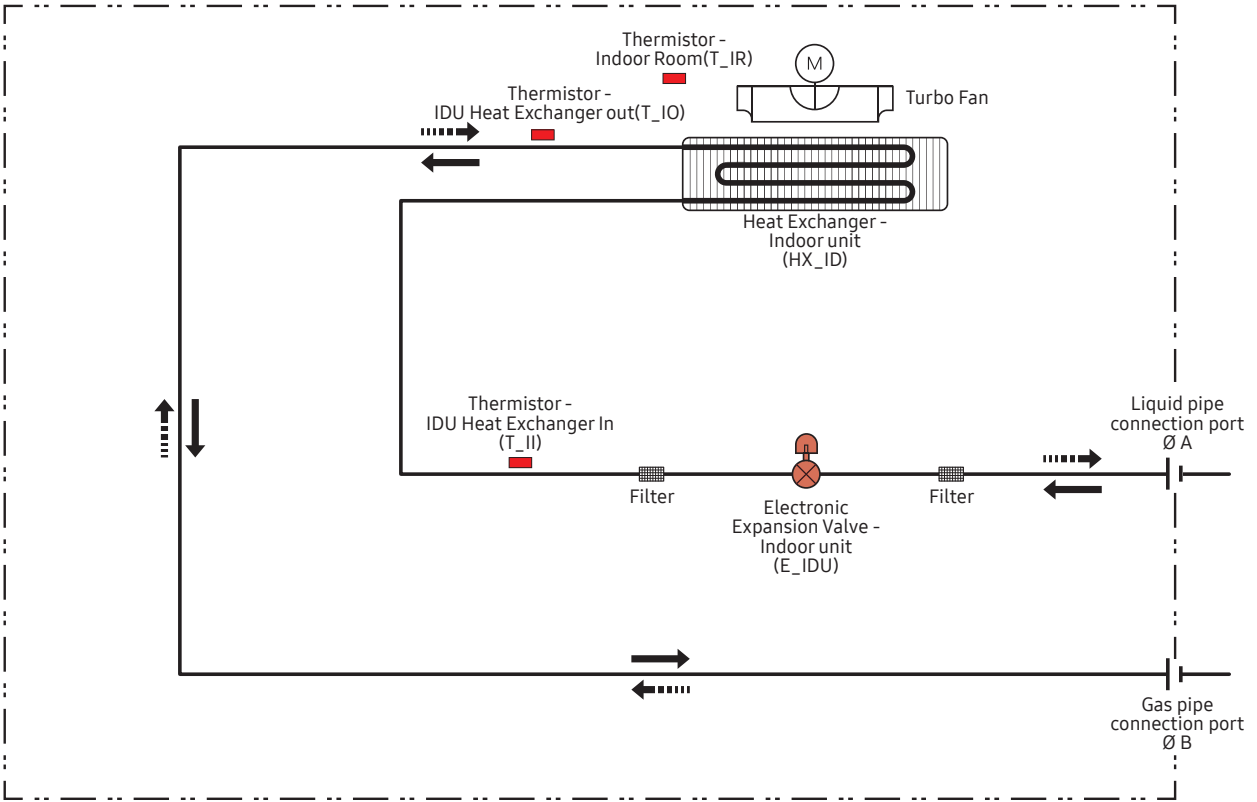

Refrigerant flow	
Cooling	Heating
→	⋯→

Unit : inches

Model	High	Mid
AM005NNNDCH/AA	1/4"	1/2"
AM007NNNDCH/AA		
AM009NNNDCH/AA		
AM012NNNDCH/AA		
AM018NNNDCH/AA		
AM020NNNDCH/AA		

A decorative background consisting of overlapping, semi-transparent blue geometric shapes, primarily triangles and quadrilaterals, creating a modern, abstract pattern. The colors range from a deep navy blue to a lighter, medium blue.

2021. 05
Ver.1.5

Samsung Electronics Co., LTD.

Head Office (Suwon Korea) 129, Samsung-Ro, Yeongtong-Gu, Suwon City, Gyeonggi-Do, Korea 16677
Website : www.samsung.com, <https://partnerhub.samsung.com> Email : airconditioner@samsung.com
Images and data in this book may subject to change without prior notice.